

Second Sunday of Lent

✦ The color vestments the priest is wearing are...

 circle your answer!



RED



GREEN



VIOLET



ROSE



WHITE

Find the path through the maze to spell the missing word.

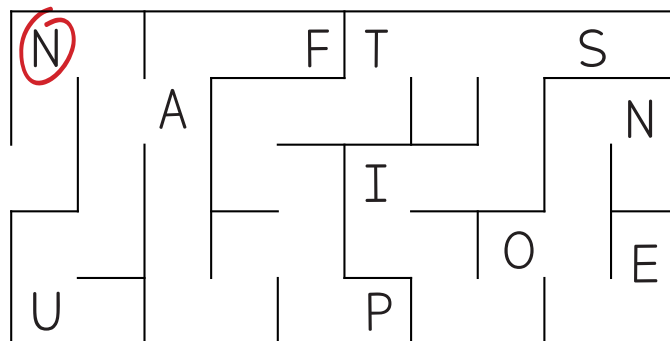

✦ The first reading is from Genesis

“The Lord said to Abram: ‘I will make of you a great ___.’”

N _____

✦ The Responsorial Psalm:

Lord, let Your mercy be on us, as we place our

trust in You.

✦ The Second Reading is from the Second Letter of Saint Paul to

Timothy

✦ The Gospel according to

Matthew

“... Behold, a bright cloud cast a shadow over them, then from the cloud came a Voice that said, ‘This is My beloved Son, with Whom I am well pleased; listen to Him.’”

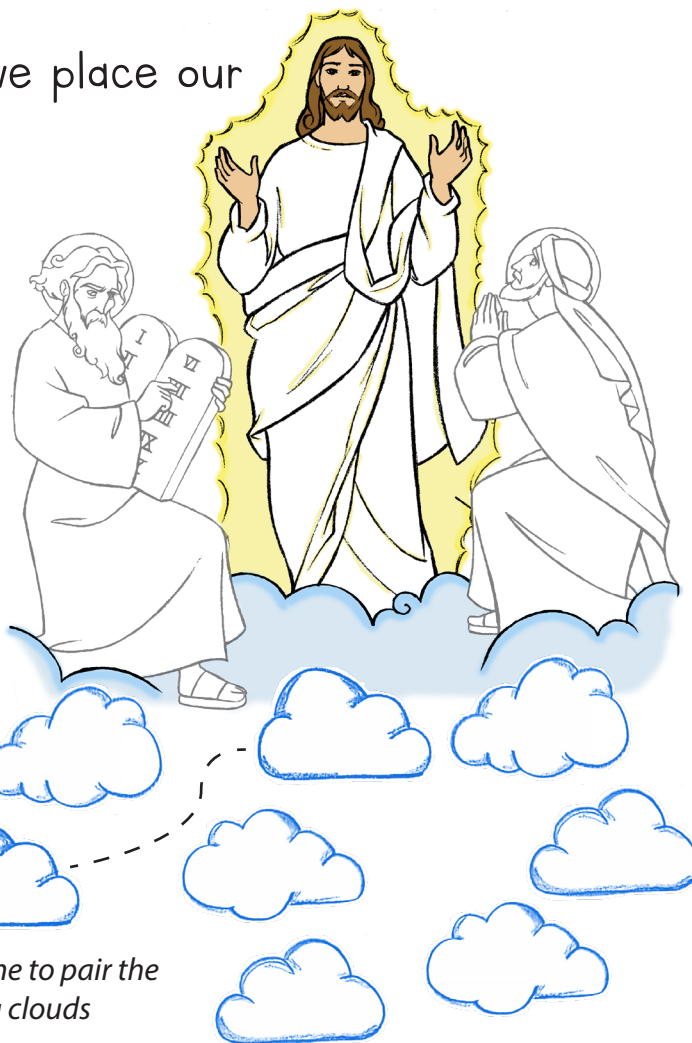

Draw a line to pair the matching clouds

Third Sunday of Lent

✦ The color vestments the priest is wearing are...

 circle your answer!



RED



GREEN



VIOLET



ROSE



WHITE

PARENTS & EDUCATORS: *Print in color for best results!*
 This worksheet is intended for children not yet reading or just learning.
 They may need simple instructions from you to complete the activities.

✦ The first reading is from

Exodus

“Strike the rock, and the water will flow from it for the people to drink.”

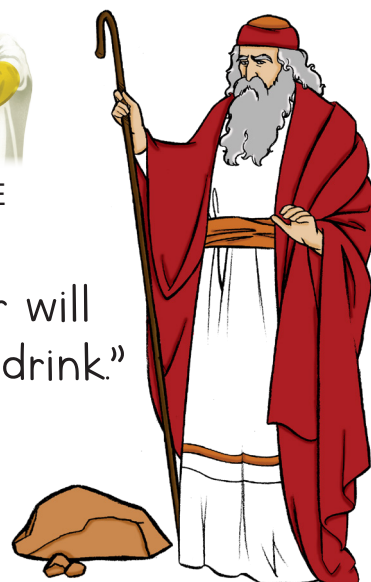

How many rocks? Write the numbers or make tally marks.

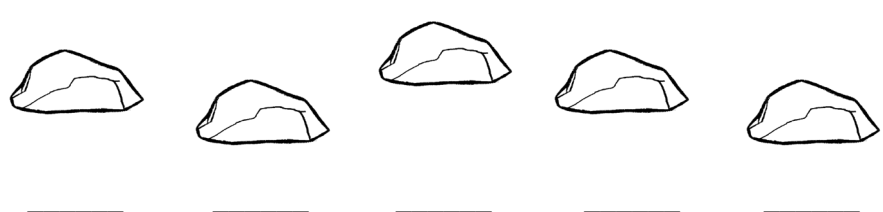

✦ The Responsorial Psalm:

If today you hear His voice, harden not your

hearts

“The water I shall give will become in him a spring of water welling up to eternal life.”

✦ The Second Reading is from the Letter of Saint Paul to the

Romans

Follow the DOT to DOT to reveal the well.

✦ The Gospel according to

John

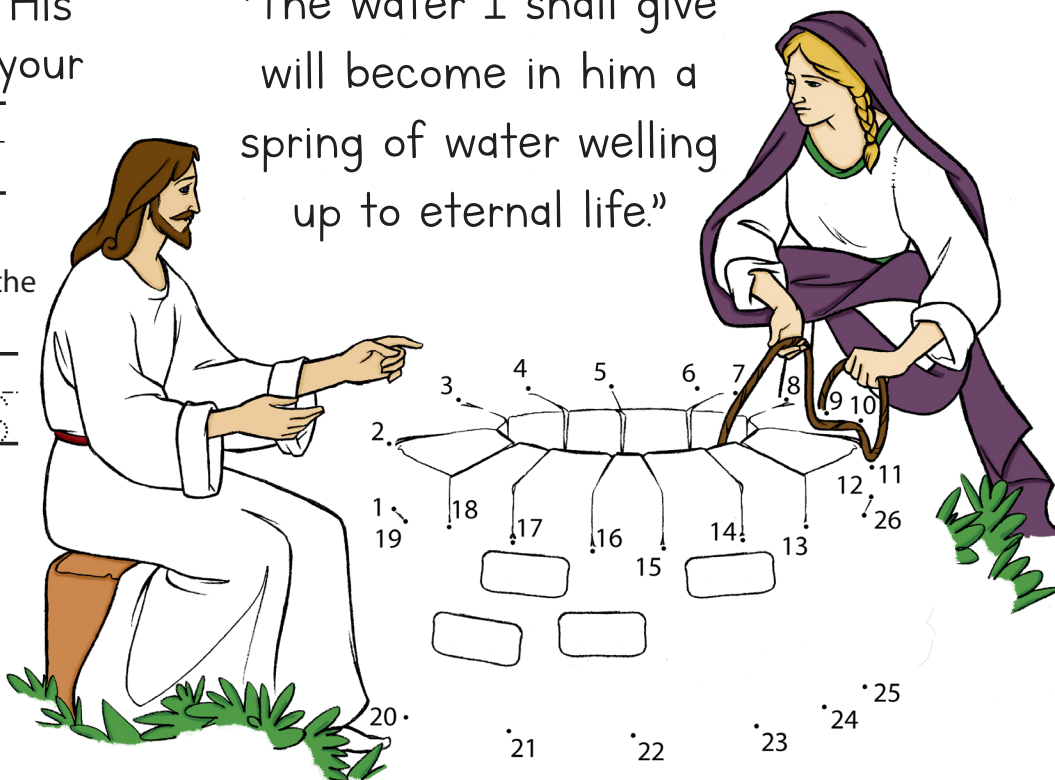

Fourth Sunday of Lent

✦ The color vestments the priest is wearing are...

 circle your answer!

PARENTS & EDUCATORS: *Print in color for best results!*
This worksheet is intended for children not yet reading or just learning.
They may need simple instructions from you to complete the activities.



RED



GREEN



VIOLET



ROSE



WHITE

✦ The first reading is from the 1st book of

Samuel

“There is still the youngest, who is tending the sheep.” Samuel said to Jesse, “Send for him.” [. . .] The Lord said, “There — anoint him, for this is the one!”

Circle the sheep that is DIFFERENT.

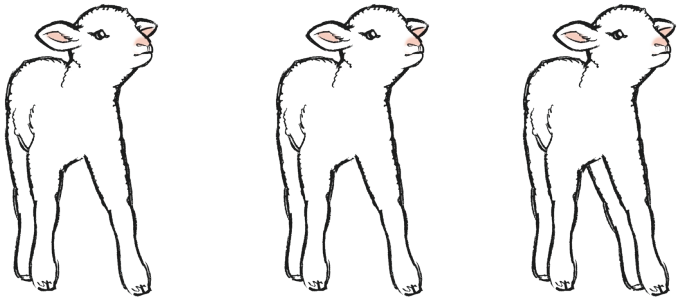

The image shows three sheep. The first two are identical, but the third is smaller and has a different posture, making it the 'different' one to be circled.

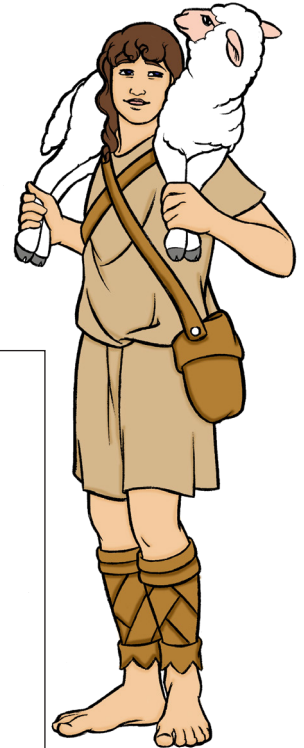

✦ The Responsorial Psalm:

The Lord is my shepherd there is nothing I shall want.

✦ The Second Reading is from the Letter of Saint Paul to the

Ephesians

✦ The Gospel according to

John

Help the blind man reach Jesus.



“The One speaking with you is He.”
[The man] said, “I do believe, Lord.”



Fifth Sunday of Lent

✦ The color vestments the priest is wearing are...

 circle your answer!

PARENTS & EDUCATORS: *Print in color for best results!*
 This worksheet is intended for children not yet reading or just learning.
 They may need simple instructions from you to complete the activities.



RED



GREEN



VIOLET



ROSE



WHITE

✦ The first reading is from

Ezekiel

✦ The Responsorial Psalm

With the Lord there is mercy and fullness of

redemption

✦ The Second Reading is from the Letter of Saint Paul to the

Romans

✦ The Gospel according to

John

Circle the Letters J and L for Jesus and Lazarus.

J P L I J F D L J O
 W J D P L W F
 L A L J H

Fill in the letters to complete the words below.
 HINT: they are the same letters you circled above!

esus cried out in a loud voice,

“ azarus, come out!”

